



W O O D F O R D
S T O V E S

Contents

PAGE 2.....	Index of Contents
PAGE 4.....	Woodford Lowry Stoves
PAGE 6.....	Woodford Turing Stoves
PAGE 8.....	Woodford Didsbury Woodburners
PAGE 10.....	Woodford Lovell Inset Stoves
PAGE 12.....	Woodford Chadwick Stove
PAGE 14.....	Fireplaces
PAGE 24.....	Chambers
PAGE 25.....	Freestanding Stoves
PAGE 27.....	Outdoor Gas Patio Heaters
PAGE 31.....	Outdoor Garden Fire Pits

The Woodford Collection is a premium range of Eco-Design Ready stoves, approved by the SiA and rated by the government's Clear Skies Scheme.

Our stoves are designed to fit the classic British fireplace and come in a range of sizes and designs that not only look great, but work in any room. All our stoves come with the latest Clean Burn technology and loads of other features as standard. They can be ordered online: www.flue-ducting.co.uk, in-store, or, with your local retailer.

Our collection of solid limestone fireplaces are some of Portugal's finest exports. Handcrafted Portuguese limestone, with matching hearths and chambers in limestone and honed slate. The selection will truly be a centrepiece of elegance and focus for any home.

We can also produce bespoke fireplaces, so please feel free to talk to your retailer about your own design.



W O O D F O R D
S T O V E S

— F R O M —

**DURA
FLUE**
TOTAL CHIMNEY SOLUTIONS



The Woodford Collection is a hand picked luxurious range of multi-fuel Stoves designed for modern living but keeping the traditional values of every British home at heart.

The Lowry Stoves



Standard features:

- SiA Ecodesign Ready
- Defra approved
- Clean Burn and Clean Glass system
- Cast iron door
- Multi-fuel
- Side riddling grate
- Primary and secondary air controls
- Direct Air as standard
- Lifetime warranty on the body of the stove
- Removable baffle

The Lowry consists of three stoves that all have a 5kw heat output and are multi-fuel; Lowry 5, Lowry 5X and the Lowry 5XL Widescreen. All the Lowry stoves are perfectly sized for every home. With all modern features as standard, this new addition to our collection truly has it all. Our Lowry stoves have a thick gauge steel body and a smooth crafted cast iron door, that give them a modern and smooth appearance. Complete with large viewing glass that will stay ultra clean due to their high efficiency and clean burn technology the Lowry stoves will look stunning in any home. Multi-fuel as standard, with a built-in riddling grate and ash pan, the Lowry stoves tick all the boxes.

The Woodford stoves have a simple, easy-to-use air control system. Two levers located under the door allow you to control the airflow into the stove, giving you amazing controllability.

The full product specification and details of all our products can be found at www.flue-ducting.co.uk.



The Lowry 5

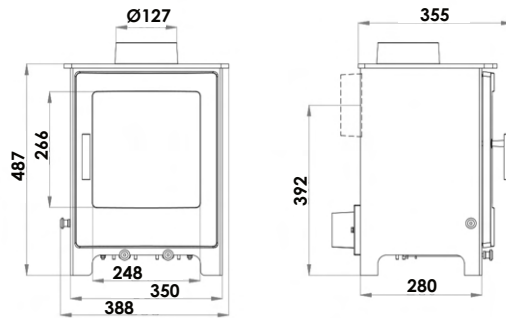

The Woodford Collection Lowry

Energy Rating: A+

Power: 5.0 kW

2015/1186

The Lowry 5X

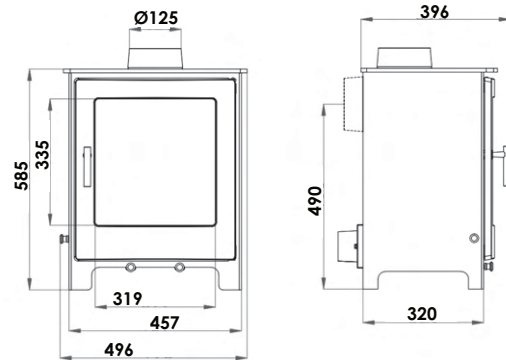

The Woodford Collection Lowry 5X

Energy Rating: A+

Power: 4.9 kW

2015/1186

The Lowry 5XL Widescreen

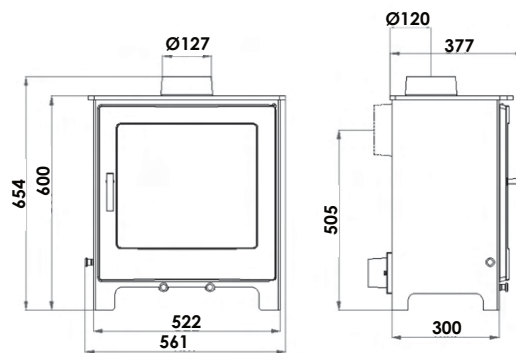

The Woodford Collection Lowry 5XL

Energy Rating: A+

Power: 4.9 kW

2015/1186

The Turing Stoves



Standard features:

- SiA Ecodesign Ready
- Defra approved
- Clean Burn and Clean Glass system
- Cast iron door
- Multi-fuel
- Side riddling grate
- Primary and secondary air controls
- Direct Air as standard
- Lifetime warranty on the body of the stove
- Removable baffle

The Turing range consists of three stoves that all have a 5kw heat output and are multi-fuel; Turing 5, Turing 5X, and our special widescreen version, the Turing 5XL Widescreen for that panoramic view of the flame. Our Turing range have fantastic practical features, they look great, and they are also some of the cleanest, most efficient multi-fuel stoves on the UK market.

The Woodford stoves have a really simple, easy-to-use air control system. Two levers located under the door allow you to control the airflow into the stove giving you amazing controllability.

The full product specification and details of all our products can be found at www.flue-ducting.co.uk.



The Turing 5

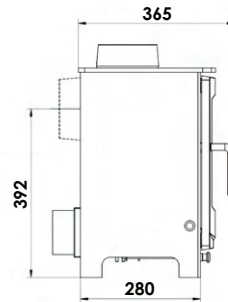
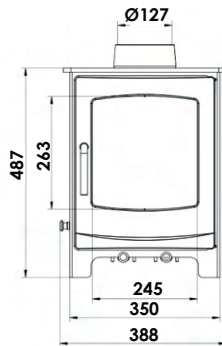

The Turing 5X

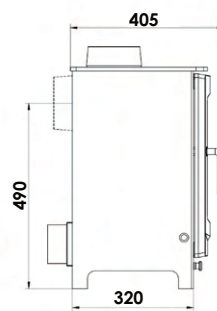
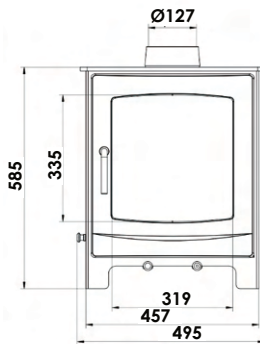

The Turing 5XL Widescreen

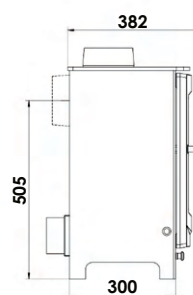
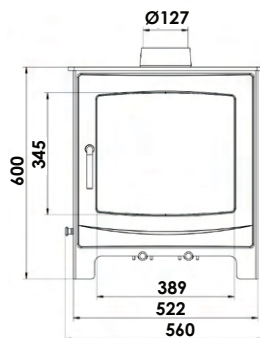

The Didsbury Wood-burners



Standard features:

- 🐝 SiA Ecodesign Ready
- 🐝 Defra approved
- 🐝 Clean Burn and Clean Glass system
- 🐝 Cast iron curved door
- 🐝 Big viewing glass
- 🐝 Direct Air as standard
- 🐝 Removable baffle
- 🐝 Lifetime warranty on the body of the stove
- 🐝 Wood-burner only (optional multi-fuel kit)

Our two, stunning premium wood-burning stoves, the Didsbury 5 and Didsbury 5 Widescreen are beautifully designed for optimal viewing of the flame. The Didsbury is our 5kw standard portrait stove and will fit almost any British fireplace. The Didsbury 5 Widescreen has all the amazing features of the 5, but has a wider viewing glass for maximum view of the fire.

The Woodford stoves have a really simple, easy-to-use air control system. Two levers located under the door allow you to control the airflow into the stove giving you amazing controllability.

The full product specification and details of all our products can be found at www.flue-ducting.co.uk.



The Didsbury 5

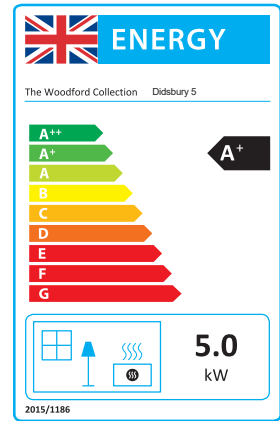
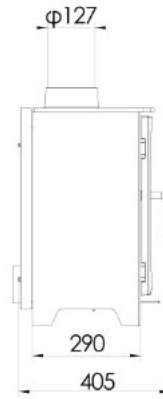
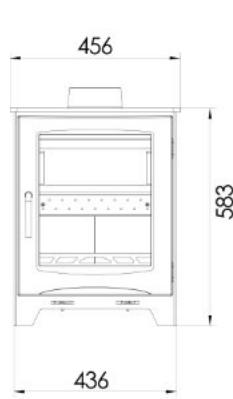

The Didsbury 5 Widescreen

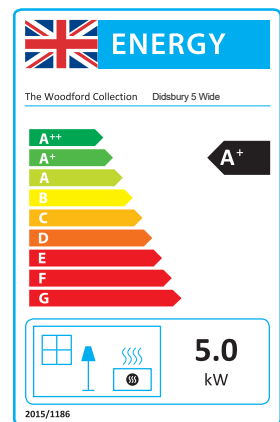
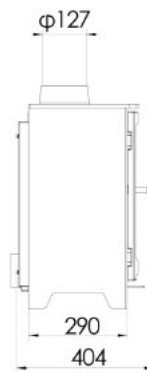
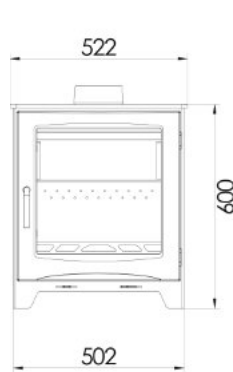

The Lovell Inset Stoves

Standard features:

- 🌿 Ecodesign Ready
- 🌿 Multi-fuel
- 🌿 Clean Burn and Clean Glass system
- 🌿 Large viewing window
- 🌿 Direct Air as standard
- 🌿 Lifetime warranty on the body

Our beautifully modern, Lovell C400 stove will enhance any room and be the main focal point. The large viewing window allows the roaring flames to be admired. This 5kw stove offers warmth and reliability in any home, or commercial property. Beautifully designed, with the modern family in mind, the Lovell C550 will enrich any room. The opulence of the stove will be admired by friends and family and is sure to be a focal point of any room. This 7kw stove offers immense warmth, style, and sophistication.

The Woodford stoves have a really simple, easy-to-use air control system. Two levers located under the door allow you to control the airflow into the stove giving you amazing controllability.

The full product specification and details of all our products can be found at www.flue-ducting.co.uk.



The Lovell C400

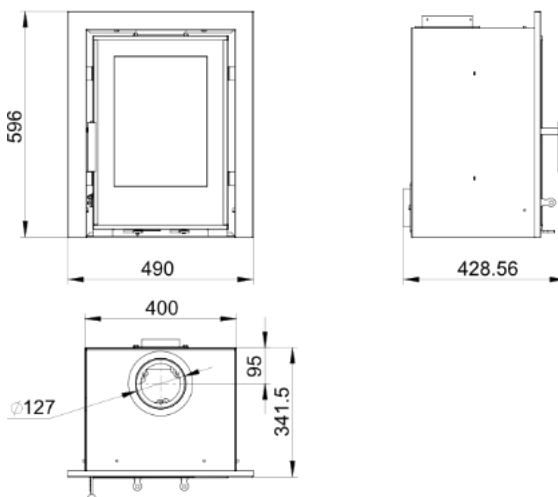

ENERGY

The Woodford Collection Lovell C400

A++	
A+	
A	
B	
C	
D	
E	
F	
G	

A+

5.0 kW

2015/1186

The Lovell C550

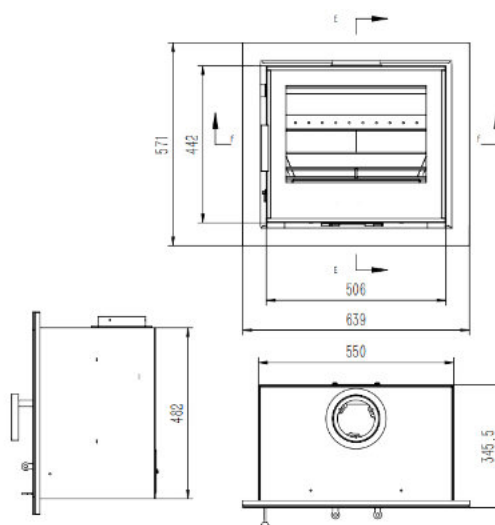

ENERGY

The Woodford Collection Lovell C550

A++	
A+	
A	
B	
C	
D	
E	
F	
G	

A

6.9 kW

2015/1186

The Chadwick Stove

Standard features:

- SiA Ecodesign Ready
- Clean Burn and Clean Glass System
- Cast iron curved door
- Multi-fuel and wood-burning stove
- Primary, secondary and tertiary controls
- Direct Air as standard
- Large viewing glass
- Lifetime warranty on the body

Our Chadwick multi-fuel stove is the newest addition to our Woodford family. An ideal size for every home, with a heat output of 4.6kw. Beautifully designed, with a large viewing glass, where you can see the roaring flames of the fire. There are three controls on the Chadwick; Primary and secondary air controls, which are used to control the fuel burn and the airwash.

There's also, the tertiary control, which is located above the window, which controls the air supply to burn off gasses. The Chadwick has a classic, elegant and timeless design will be an optimal focal point of any home.

The full product specification and details of all our products can be found at www.flue-ducting.co.uk.



The Chadwick

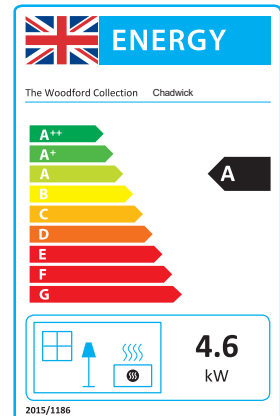
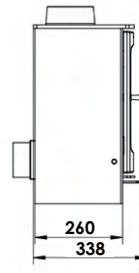
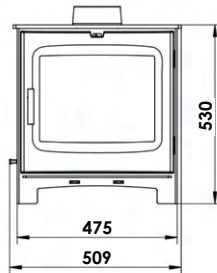

What is Ecodesign?

On 1st January 2022, the European Union implemented a new regulation called Eco-Design, which means that all new stoves need to meet the agreed emissions standards, this also coincides with the Clean Air Strategy. Eco-Design stove produces on average 90% less emissions than an open fire, and approximately 80% less emissions than a stove that's 10 years old.

Woodsure & Ready To Burn Fuels

We recommend you use Woodsure & Ready To Burn certified fuel for all our stoves. Woodsure is the UK's only woodfuel quality assurance scheme.

Why Woodsure & Ready To Burn?

Woodsure & Ready To Burn are the accreditation given to woodfuel in the industry. It's fuel that's been backed by DEFRA to support The Air Quality Regulations 2022 with the goal of reducing emissions. It's fuel that's been treated in order to meet these standards.

If you've got a wood burner or stove, you need to make sure that you're buying fuel that carries the '**Ready to Burn**' mark. The **Ready to Burn** mark means that the wood has a moisture content of no more than 20%.

The **Ready to Burn** mark is run by Woodsure Ltd, a not-for-profit, DEFRA appointed Certification Body. It's the job of Woodsure to administer the **Ready to Burn** mark and to ensure that all wood sold after the 1st May 2021 complies with the *Air Quality (Domestic Solid Fuels Standard) (England) Regulations 2020*.





The Sutton is simply brilliant, combining modern clean edges with a small traditional shelf makes the fireplace suitable for any living area. Neat, tidy, and practically everything you need from a fireplace, the Sutton offers it all. Made from solid natural Portuguese Limestone the Sutton is crafted to perfection. The Sutton fits with any of our chambers, slips, and hearth options. It is also suitable for use with any appliance and any type of fuel.

Please note this is the Fireplace only, chambers, slips, and hearths are not included and all need to be ordered separately.

All of our Fireplaces come with a 40mm rebate as standard, if you need anything bespoke please provide us with a drawing.

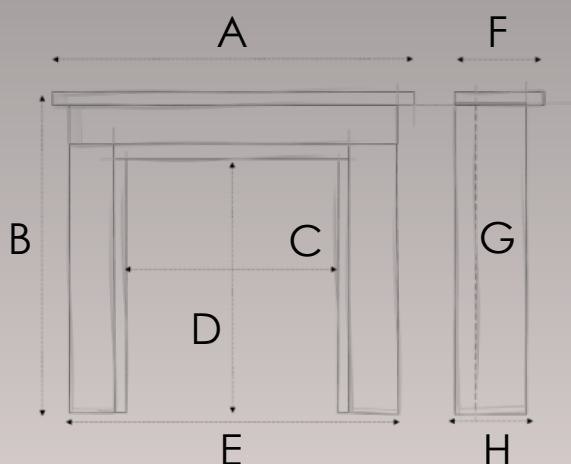

Mantel Width(A)	1370mm
Overall Height (B)	1100mm
Opening Width (C)	870mm
Opening Height (D)	850mm
Body Width (E)	1270mm
Shelf Depth (F)	200mm
Rebate (G)	40mm
Body Depth (H)	150mm





The Harlech is a masterpiece in contemporary design and fits superbly with modern living and open-plan spaces. Square sharp lines with no detailing the Harlech has been designed for the most contemporary of homes. Made from solid natural Portuguese Limestone the Harlech is crafted to perfection. The Harlech fits with any of our chambers, slips, and hearth options. It is also suitable for use with any appliance and any type of fuel.

Please note this is the Fireplace only, chambers, slips, and hearths are not included and all need to be ordered separately.

All of our Fireplaces come with a 40mm rebate as standard, if you need anything bespoke, please provide us with a drawing.

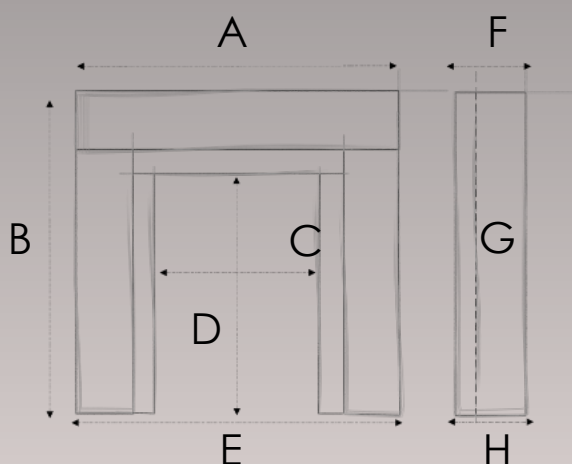

Mantel Width(A)	1320mm
Overall Height (B)	1090mm
Opening Width (C)	780mm
Opening Height (D)	810mm
Body Width (E)	1320mm
Shelf Depth (F)	180mm
Rebate (G)	40mm
Body Depth (H)	180mm





The Attwood is simply elegant, with a small amount of fine detail it oozes elegance but sits quietly making for a beautiful fireplace. The Attwood can be fitted in a traditional or a more contemporary setting so it's perfect for any type of home. Made from solid natural Portuguese Limestone the Attwood is crafted to perfection. The Attwood fits with any of our chambers, slips, and hearth options. It is also suitable for use with any appliance and any type of fuel.

Please note this is the Fireplace only, chambers, slips, and hearths are not included and all need to be ordered separately.

All of our Fireplaces come with a 40mm rebate as standard, if you need anything bespoke please provide us with a drawing.

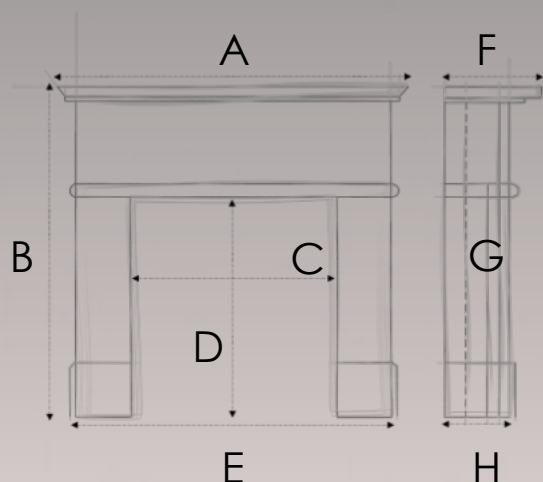

Mantel Width(A)	1320mm
Overall Height (B)	1110mm
Opening Width (C)	900mm
Opening Height (D)	850mm
Body Width (E)	1200mm
Shelf Depth (F)	190mm
Rebate (G)	40mm
Body Depth (H)	120mm





The Kildare is balanced between the traditional arched fireplace with a twist of a more modern style, suitable for all home types the Kildare is a true classic within our collection. Made from solid natural Portuguese Limestone the Kildare is crafted to perfection. The Kildare fits with any of our chambers, slips, and hearth options. It is also suitable for use with any appliance and any type of fuel.

Please note this is the Fireplace only, chambers, slips, and hearths are not included and all need to be ordered separately.

All of our Fireplaces come with a 40mm rebate as standard, if you need anything bespoke please provide us with a drawing.

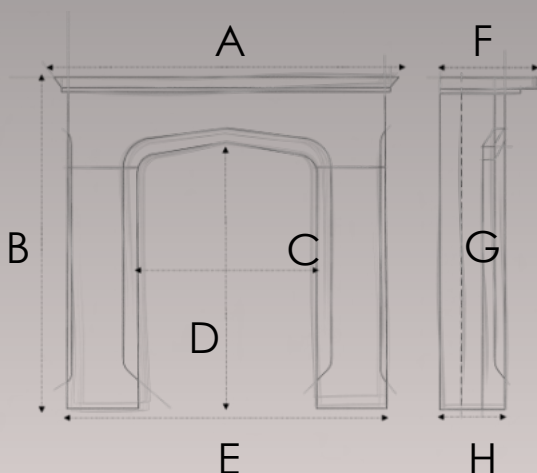

Mantel Width(A)	1270mm
Overall Height (B)	1010mm
Opening Width (C)	770mm
Opening Height (D)	780mm
Body Width (E)	1170mm
Shelf Depth (F)	200mm
Rebate (G)	40mm
Body Depth (H)	150mm





The Bamford has the classic look, bold and elegant it suits any upmarket living space to create a truly luxurious fireplace setting. Clean lines and fine detailing make this fireplace a must have for any homeowner. Made from solid natural Portuguese Limestone the Bamford is crafted to perfection. The Bamford fits with any of our chambers, slips and hearth options. It is also suitable for use with any appliance and any type of fuel.

Please note this is the Fireplace only, chambers, slips and hearths are not included and all need to be ordered separately.

All of our Fireplaces come with a 40mm rebate as standard, if you need anything bespoke please provide us with a drawing.

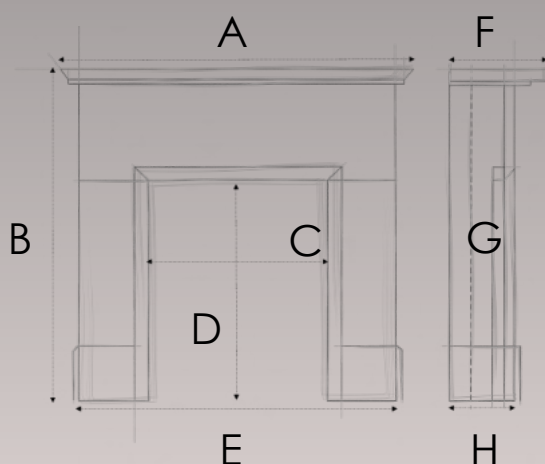

Mantel Width (A)	1370mm
Overall Height (B)	1120mm
Opening Width (C)	770mm
Opening Height (D)	820mm
Body Width (E)	1250mm
Shelf Depth (F)	210mm
Rebate (G)	40mm
Body Depth (H)	145mm

Chambers

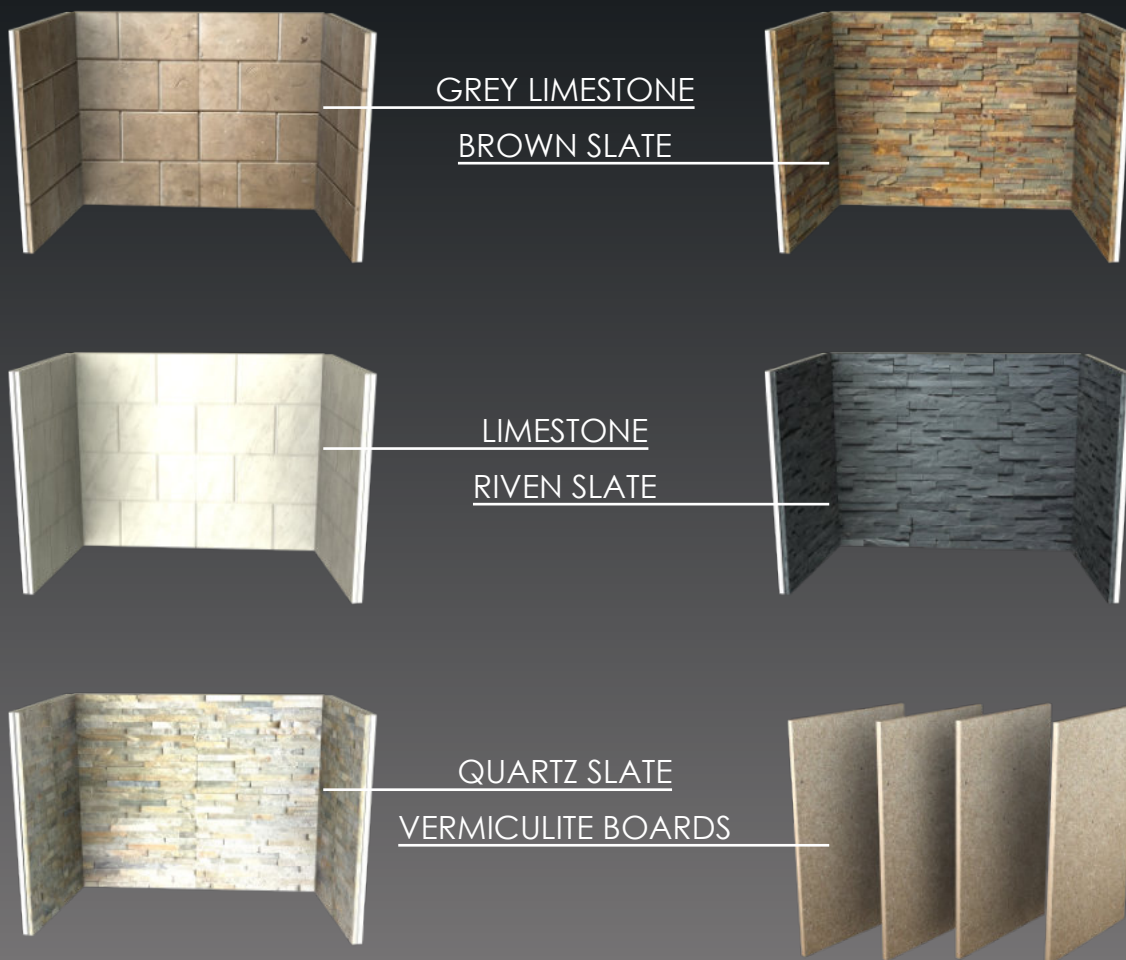

Grey limestone – Our unique grey limestone chambers are absolutely stunning and come in a block effect. They are sized to fit nearly every standard fireplace opening but can be cut down easily if required. They come in 4 easy-to-manage panels, 2x side panels at 410mm x 900mm, and a 2-piece back panel measuring 470mm x 900mm. They are solid grey Portuguese limestone panels with a block effect pattern.

Brushed limestone – Fantastic looking brushed natural limestone chambers with a block effect. They are sized to fit nearly every standard fireplace opening but can be cut down easily if required. They come in 4 easy-to-manage panels, 2x side panels at 410mm x 900mm, and a 2-piece back panel measuring 470mm x 900mm. They are solid Portuguese limestone panels with a block effect pattern.

Slate Chambers – Our Quartz, Brown and Riven slate chambers are hand-built slate chambers mounted onto a ceramic tile, this gives for an impressive effect and enlightens any fireplace. They come in 4 pieces of 2x side panels 410mm x 900mm and a 2-piece back panel measuring 450mm x 900mm.

Vermiculite board – Another option is to board the inside of the fireplace with a plain vermiculite board, it's a Skamol board and is heat resistant. The boards are sold individually and measure 997mm x 610mm and come either 25mm or 30mm in depth.

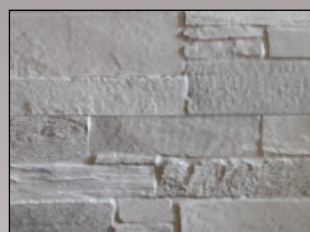

Blanco

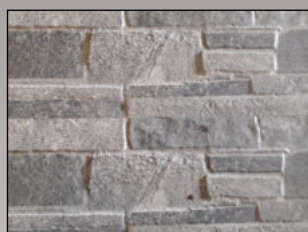

Grafit



Tolanco



Toris

Half chamber: 1x 960h x 985w
 Full chamber: 1x 960h x 985w (Back), 2x 960h x 490w (Sides)

A freestanding wood-burning stove with a fire burning inside, set in a room with blue walls and a wooden floor. The stove is dark-colored and has a curved front. A fire is visible through the glass door of the stove. The room has blue walls and a wooden floor. A white door with glass panels is visible on the left side of the image.

Freestanding Stoves

A modern and ecological freestanding stove, distinguished by its interesting design and excellent parameters, as well as user-friendliness thanks to its intuitive operation with a remote control.

Dalton Stove

A cylindrical, modern design stove is a great solution for people who long for warmth, but do not have a large space in their interior.

Rated Output: 8.0kW
 Range of Heating Power: 5.5-10.2kW
 Efficiency: 78.0%
 Glazing Type: Quadrant
 Material: Steel, cast iron
 Fuel Type: Wood burning only
 Designed for Heat Recovery Unit: Yes
 Flue Gas Temperature: 265°C
 Exhaust log Length: 250mm
 Weight: 110kg

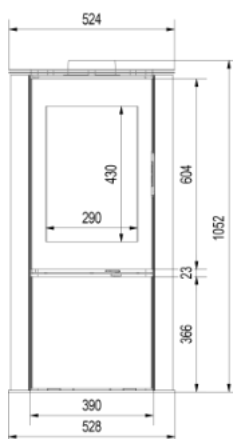
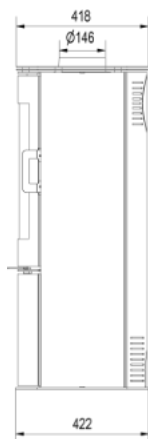
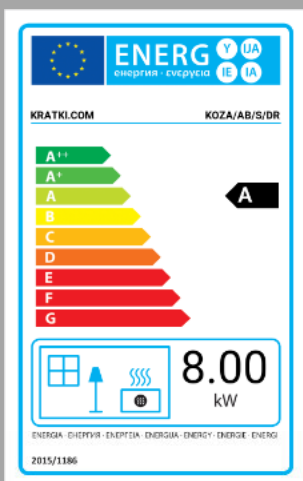

Turin Gas Stove

A modern and ecological freestanding stove, distinguished by its interesting design and excellent parameters, as well as user-friendliness thanks to its intuitive operation with a remote control.

Rated Output: 4.9kW
 Range of Heating Power: 2.7-5.2kW
 Efficiency: 80.1%
 Glazing Type: Quadrant
 Material: Steel
 Fuel Type: Gas
 Designed for Heat Recovery Unit: Yes
 Weight: 104kg

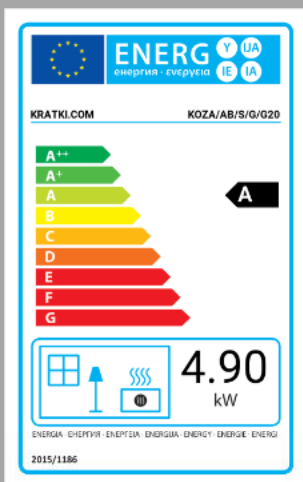

COMPATIBLE WITH OUR
 BALANCED FLUE
 GAS SYSTEM

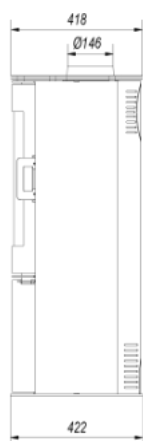
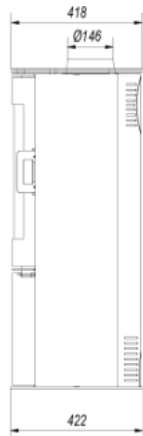



Outdoor Gas Patio Heaters

The Woodford Outdoor Gas Patio Heaters are stylish gas heaters which provide heat and light wherever you want to create a unique and cosy atmosphere. Its unique feature is fire visible on four sides.

Gas Mini Patio Heaters

Our Mini Patio Heater is a stylish gas heater which provides heat and light wherever you want to create a unique and cosy atmosphere. Our compact and modern Mini Patio Heater suits almost any location.

The heater can be an elegant decoration on the home's terrace or in the garden. It can be also used in restoration as well as hotel industry as an interesting addition to the dining and leisure area. The attractive appearance and pleasurable warmth of Mini Patio Heater will make gardens and terraces full of guests during spring, summer as well as winter evenings. Natural fire vision is ensured by the use of a modern ceramic burner. Additionally, decorative elements such as stones or decorative glass can be used in Mini Patio Heater to enhance the look of the heater.

Mini Patio Heater Black:

Overall Height: 1360mm
Overall Width: 442mm
Overall Depth: 442mm
Rated Output: 8.2kW
Weight: 64kg

Mini Patio Heater White:

Overall Height: 1360mm
Overall Width: 442mm
Overall Depth: 442mm
Rated Output: 8.2kW
Weight: 64kg

Mini Patio Heater Matt Steel:

Overall Height: 1366mm
Overall Width: 427mm
Overall Depth: 427mm
Rated Output: 8.2kW
Weight: 60kg



Please note you will need to purchase your own connector separately depending on the gas bottle you have, these heaters work on propane and are suitable for indoor and outdoor use. Available in Black, White and Matt Steel finish.



Gas Patio Heaters

Patio Heater is a stylish gas heater which provides heat and light wherever we want to create a unique and cosy atmosphere. Its unique feature is fire visible on four sides. Thanks to this, it is the one and only gas or terrace garden lamp.

Compact and modern gas heater Patio Heater suits almost anywhere. The heater can be an elegant decoration on the home's terrace or in the garden. It can be also used in restoration as well as hotel industry as an interesting addition to the dining and leisure area. The attractive appearance and pleasurable warmth of Patio Heater will make gardens and terraces full of guests during spring, summer as well as winter evenings. Natural fire vision is ensured by the use of a modern ceramic burner. Additionally, decorative elements such as stones or decorative glass can be used in Patio Heater to enhance the look of the heater.

Available in Black finish.

Patio Heater Black:

Overall Height: 1553mm

Overall Width: 467mm

Overall Depth: 467mm

Rated Output: 8.2kW

Weight: 63kg



Umbrella Gas Patio Heater

Umbrella Heater is a stylish gas heater which provides heat and light wherever we want to create a unique and cosy atmosphere. Its unique feature is fire visible on four sides. Thanks to this, it is the one and only gas or terrace garden lamp.

Compact and modern Umbrella Heater suits almost anywhere. The heater can be an elegant decoration on the home's terrace or in the garden. It can be also used in restoration as well as hotel industry as an interesting addition to the dining and leisure area. The attractive appearance and pleasurable warmth of Umbrella Heater will make gardens and terraces full of guests during spring, summer as well as winter evenings. Natural fire vision is ensured by the use of a modern ceramic burner. Additionally, decorative elements such as stones or decorative glass can be used in Umbrella Heater to enhance the look of the heater.

Available in Black finish.

Umbrella Patio Heater Black:

Overall Height: 2163mm

Overall Width: 501mm

Overall Depth: 501mm

Rated Output: 8.2kW

Weight: 48kg

Please note you will need to purchase your own connector separately depending on the gas bottle you have, these heaters work on propane and are suitable for indoor and outdoor use.

Gas Patio Heater Covers

Black Mini Gas Patio Heater Textile Cover. Composition: surface - 100% Polyester; PVC primer. Density: 490 g/m². Waterproof.

Mini Gas Patio Heater Cover:

Overall Height: 1290mm
Overall Width: 460mm
Overall Depth: 460mm
Weight: 1.2kg

Gas Patio Heater Cover:

Overall Height: 1470mm
Overall Width: 500mm
Overall Depth: 500mm
Weight: 1.2kg

Black Umbrella Gas Patio Heater Textile Cover. Composition: surface - 100% Polyester; PVC primer. Density: 490 g/m². Waterproof.

Gas Umbrella Patio Heater Cover:

Overall Height: 1470mm
Overall Width: 500mm
Overall Depth: 500mm
Weight: 1.2kg



Decorative Black Crystal Stones

Decorative glass stones create an interesting and aesthetic finish in the biofireplaces, gas fireplaces and gas heaters. They can be arranged easily around the burner. They are temperature resistant up to 600°C.

Decorative Black Crystal Stones:

Weight: 1.0kg



A lush garden at dusk. In the foreground, a modern black metal fire pit sits on a green lawn, with a fire burning inside. Behind it, a circular stone fire pit is visible. The background features a large tree with dense foliage, a stone wall, and several garden lights. The scene is illuminated by warm, golden light from the setting sun.

Outdoor Garden Fire Pits

The high quality freestanding garden fire pit is a unique and extremely modern decoration created for the most demanding users of terraces and gardens. It can be an interesting decorative garden element to create a nice and cosy atmosphere.

Sunny Garden Fire Pit

The high quality freestanding garden fire pit is a unique and extremely modern decoration created for the most demanding users of terraces and gardens. It can be an interesting decorative element and at the same time create a nice and cosy atmosphere.

Sunny Garden Fire Pit:

Overall Height: 113mm

Overall Width: 684mm

Overall Depth: 684mm

Weight: 10.5kg



Erizo 50 Garden Fire Pit

The high quality freestanding garden fire pit is a unique and extremely modern decoration created for the most demanding users of terraces and gardens. It can be an interesting decorative element and at the same time create a nice and cosy atmosphere.

Erizo 50 Garden Fire Pit:

Overall Height: 175mm

Overall Width: 500mm

Overall Depth: 500mm

Weight: 40.8kg



Gamma Garden Fire Pit

The high quality freestanding garden fire pit is a unique and extremely modern decoration created for the most demanding users of terraces and gardens. It can be an interesting decorative element and at the same time create a nice and cosy atmosphere.

Gamma Garden Fire Pit:
Overall Height: 225mm
Overall Width: 692mm
Overall Depth: 605mm
Weight: 16.0kg

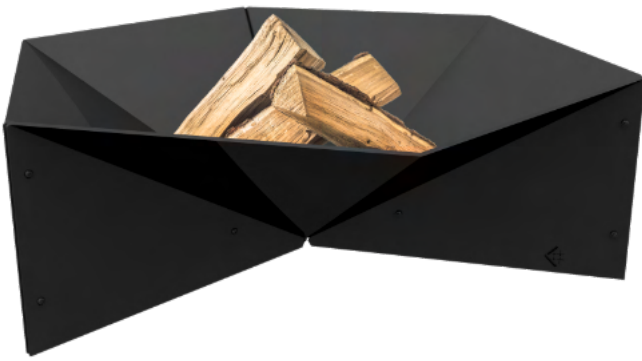

Pit Garden Fire Pit

The high quality freestanding garden fire pit is a unique and extremely modern decoration created for the most demanding users of terraces and gardens. It can be an interesting decorative element and at the same time create a nice and cosy atmosphere.

Pit Garden Fire Pit:
Overall Height: 652mm
Overall Width: 692mm
Overall Depth: 705mm
Weight: 18.3kg



Pyramid Garden Fire Pit

The high quality freestanding garden fire pit is a unique and extremely modern decoration created for the most demanding users of terraces and gardens. It can be an interesting decorative element and at the same time create a nice and cosy atmosphere.

Pyramid Garden Fire Pit:

Overall Height: 227mm

Overall Width: 790mm

Overall Depth: 685mm

Weight: 16.8kg



Hex Garden Fire Pit

The high quality freestanding garden fire pit is a unique and extremely modern decoration created for the most demanding users of terraces and gardens. It can be an interesting decorative element and at the same time create a nice and cosy atmosphere.

Hex Garden Fire Pit:

Overall Height: 419mm

Overall Width: 660mm

Overall Depth: 572mm

Weight: 17.7kg



Order online today easily!

Visit our new website www.flue-ducting.co.uk or contact us at sales@flue-ducting.co.uk

REGISTER TODAY FOR TRADE DISCOUNTS

Open Monday to Friday 8am - 4.30pm ☎ 0161 480 2894 👤 Sign in or Register

**DURA
FLUE**
TOTAL CHIMNEY SOLUTIONS

Search the store



Cart

- FLEXIBLE CHIMNEY LINERS
- TWIN WALL FLUE SYSTEMS
- STOVE PIPES
- THE WOODFORD COLLECTION
- HOUSE DEVELOPERS AND ARCHITECTS
- COMMERCIAL
- OUTDOOR LIVING
- THERMAFLUE
- ROOF FLASHINGS
- WOVEN HILL LOG BASKETS
- OFFERS

REGISTER TODAY FOR TRADE DISCOUNTS

**WOODFORD
STOVES**



SOMERSET TRADE COUNTER



STOCKPORT TRADE COUNTER

**STOVE
BUNDLES**



COUNTY ANTRIM TRADE COUNTER

SHOP
**FLEXIBLE
CHIMNEY
LINER**



SHOP
**ECO
DESIGN
READY
STOVES**



SHOP
**INSULATED
TWIN WALL
FLUE**



SHOP
**BALANCED
FLUES**



SHOP
ROOFING

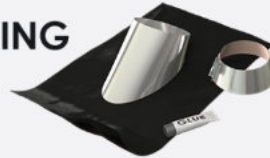

SHOP
FIREPLACES



SHOP
**PATIO
HEATERS
FIRE PITS**



SHOP
**STOVE
PIPES**



SHOP
**STOVE
FANS
AND
ACCESSORIES**

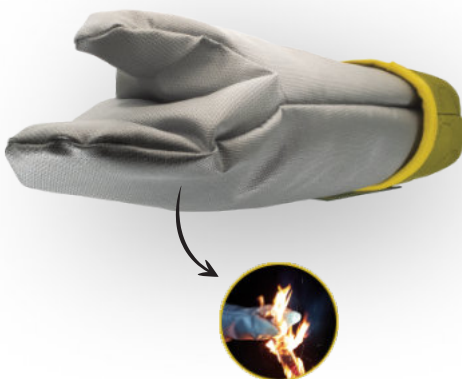

Woodford Glove

Our new Woodford glove is not just another regular stove glove .

The outside part of the glove is manufactured with the latest technological materials. It is designed to withstand temperatures +500C and incorporates Kevlar braided stainless steel thread.

The inner lining is made from a plush, comfortable durable fabric very cosy feeling but durable furniture covering cloth.



WOODFORD
STOVES

— FROM —
**DURA
FLUE**
TOTAL CHIMNEY SOLUTIONS

Flue & Ducting Ltd.
Unit D6, Stockport Trading Estate
Yew Street, Stockport
SK4 2JZ
0161 480 2994

Flue & Ducting Ltd.
8E Castle Road, Chelston Business Park
Wellington
TA21 9JQ
01823 664 684

Flue & Ducting Ltd.
Unit 16, Avondale Business Park
Ballyclare
BT39 9AU
07702 843431

Flue & Ducting Ltd.
15 Sherwood Road
Bromsgrove
B60 3DR
0161 480 2994



0161 480 2994



SALES@FLUE-DUCTING.CO.UK



WWW.FLUE-DUCTING.CO.UK

